



## ***Power travel with us*** Product Manual

ECI has spread its sales network across the globe with the honorable customer, in USA, Italy, C.Z., Turkey, Spain, Iran, Russia, Brazil, Mexico, Peru, Korea, Vietnam, Philippine, Indonesia, etc.

### **EC INSULATORS GROUP**

#### **Shanghai Office:**

Add: Room 902B, NO. 1277, Xinsongjiang Road, Songjiang District, Shanghai, China  
Tel: 0086-21-60709580  
Fax: 0086-21-51062546  
Email: [info@ec-insulators.com](mailto:info@ec-insulators.com)  
Website: [www.ec-insulators.com](http://www.ec-insulators.com)

#### **Jiangxi factory:**

Add: Yuanyang Road, Wuyuan Industrial Zone, Wuyuan, Shangrao, Jiangxi, China  
Tel: 0086-793-7296181  
Fax: 0086-21-51062546  
Email: [info@ec-insulators.com](mailto:info@ec-insulators.com)  
Website: [www.ec-insulators.com](http://www.ec-insulators.com)



**EC INSULATORS GROUP.**



## ▶ COMPANY INTRODUCTION

EC Insulator is one of the global electrical components Chinese manufacturer. with office in Shanghai and factory located in Jiangxi.

We especially produce polymer insulator from 1KV-750KV, plastic insulator, silicone & porcelain cutout, surge arrester, silicone compound, FRP rod, forging fittings and other electrical products. Certified with ISO 9001-2015, ECI has the most professional R&D team, fully equipped with testing facilities, most advanced automatic silicone injection machines, sound detecting and PLC controlled crimping machines, advanced technical supports and professional management system from Europe. ECI has been thriving on supplying the products according to the International standards of ANSI, IEC and GB standards, and has been certified and approved by third party laboratory, such as China National Insulators and Surge Arrester Quality Supervision & Inspection Center and Quality Inspection and test center for Equipment of Electric Power.

Power travel with us, ECI has been succeeded to supply the new technology, stable qualified products in the markets with more than 15 years experiences in the insulator industry and has been approved as the most reliable manufacturers by clients. ECI has spread its sales network across the world with honorable customers from the US, Italy, C.Z., Turkey, Spain, Iran, Russia, Brazil, Mexico, Peru, Korea, Vietnam, Philippine, Indonesia, etc. ECI has succeeded to sell annually 4 million pieces of insulators, cutouts and surge arrestors in the past years and has been playing a key role in this industry all the way.

To be the better and the best, ECI are trying to be one of the best suppliers for utilities globally. Transfer our "power" to meet with all your requirements, we welcome your inquiry and visit at any time.

## ▶ FACTORY PANORAMA



## ▶ OFFICE VIEW



## ▶ INSULATOR INJECTION WORKSHOP



## ▶ END FITTINGS FORGING&MACHINING WORKSHOP



## ▶ CUTOUT& ARRESTOR ASSEMBLING WORKSHOP



## ▶ FRP ROD PULTRUSION WORKSHOP



## ▶ SILICONE COMPOUND MIXING WORKSHOP



## ▶ TEST CENTER



## ▶ SUSPENSION INSULATOR

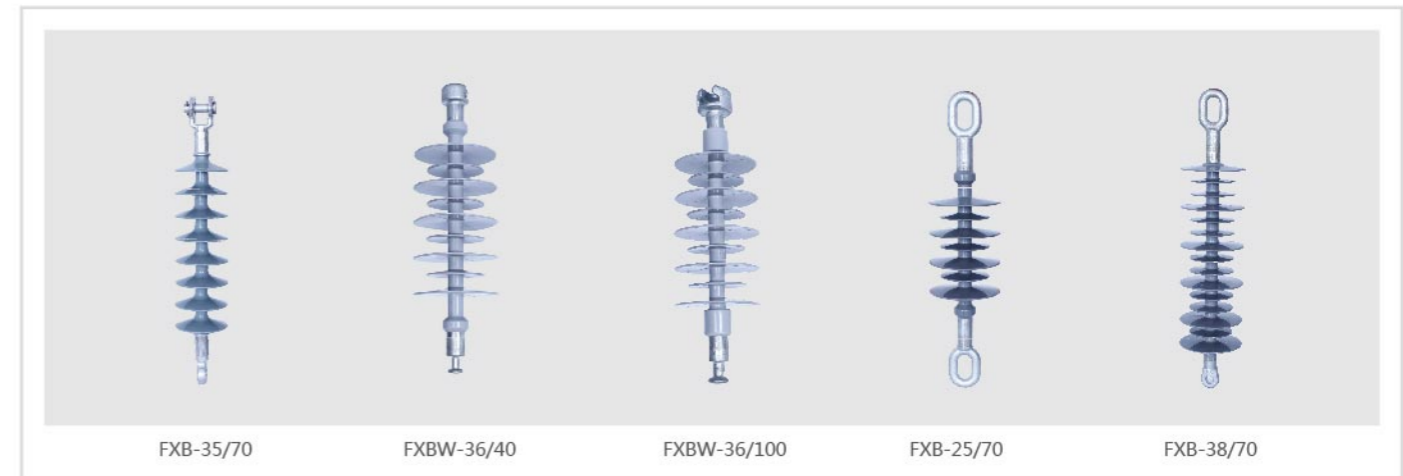

## ▶ BUSHING



## ▶ SUSPENSION INSULATOR

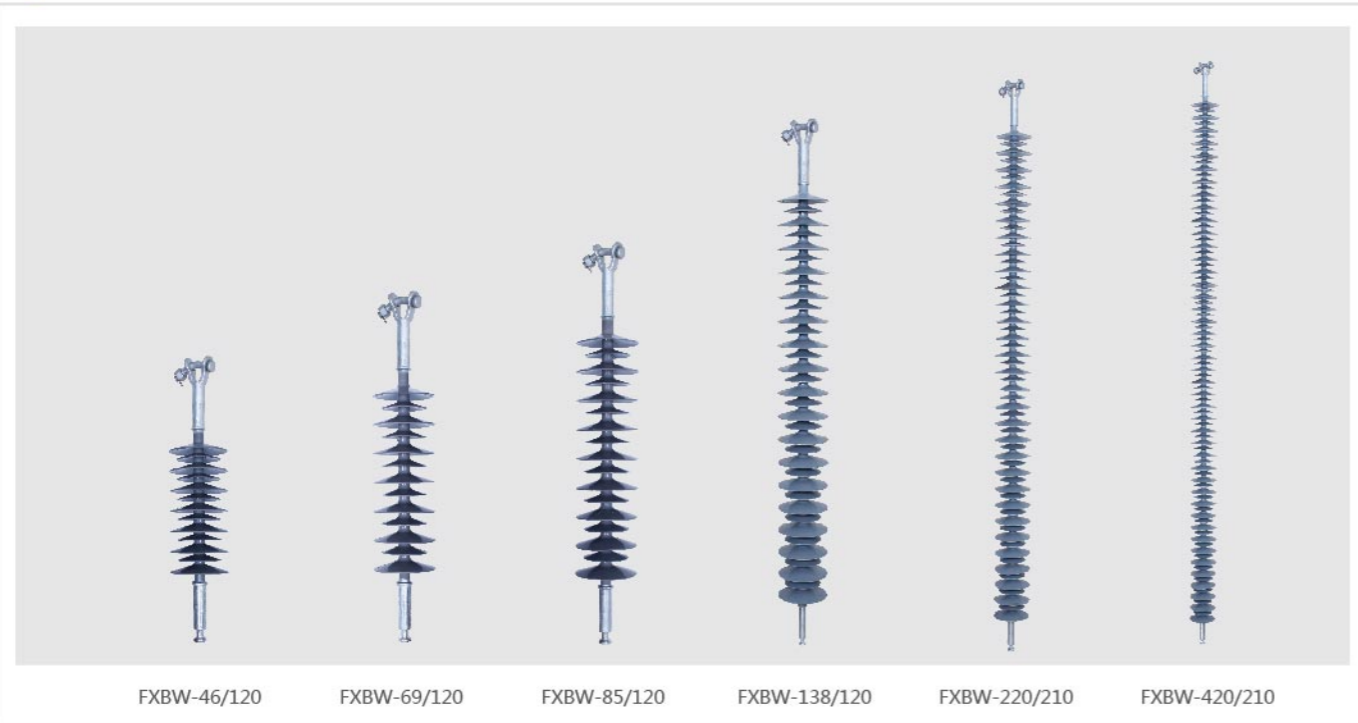

## ▶ SUSPENSION INSULATOR

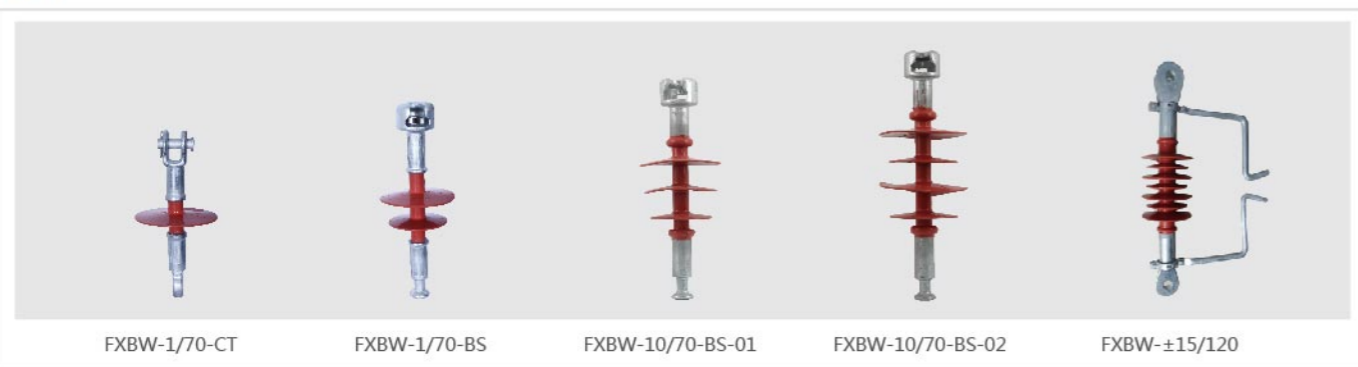

## ▶ PIN INSULATOR



## ▶ POST INSULATOR



## ▶ POST INSULATOR



## ▶ LINE POST INSULATOR

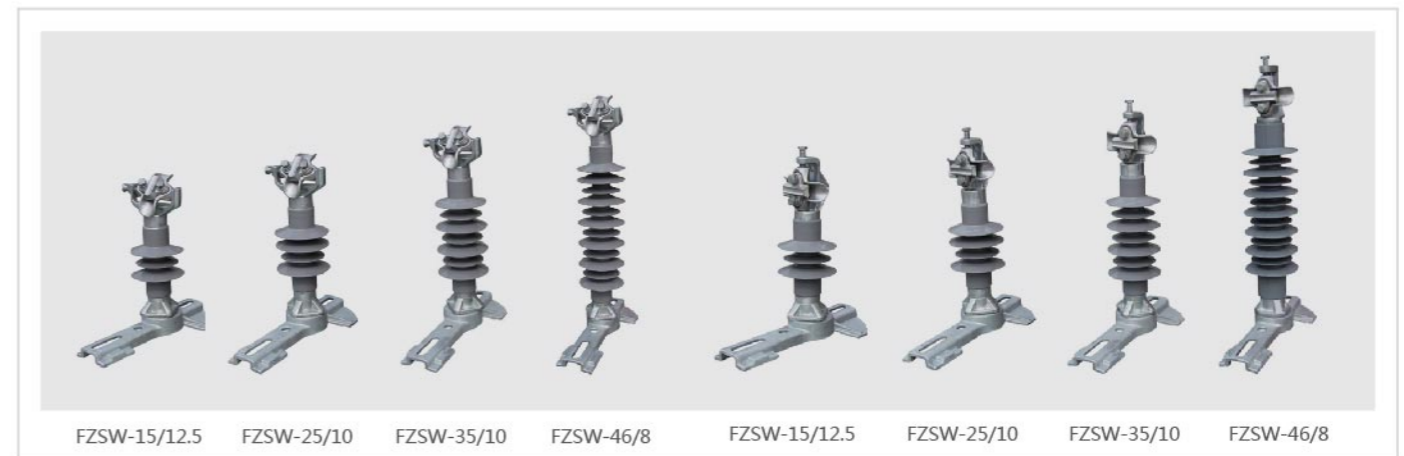

## ▶ PIN POST INSULATOR



## ▶ PIN POST INSULATOR



## ▶ POLYMER RAILWAY INSULATOR



## ▶ POST INSULATOR

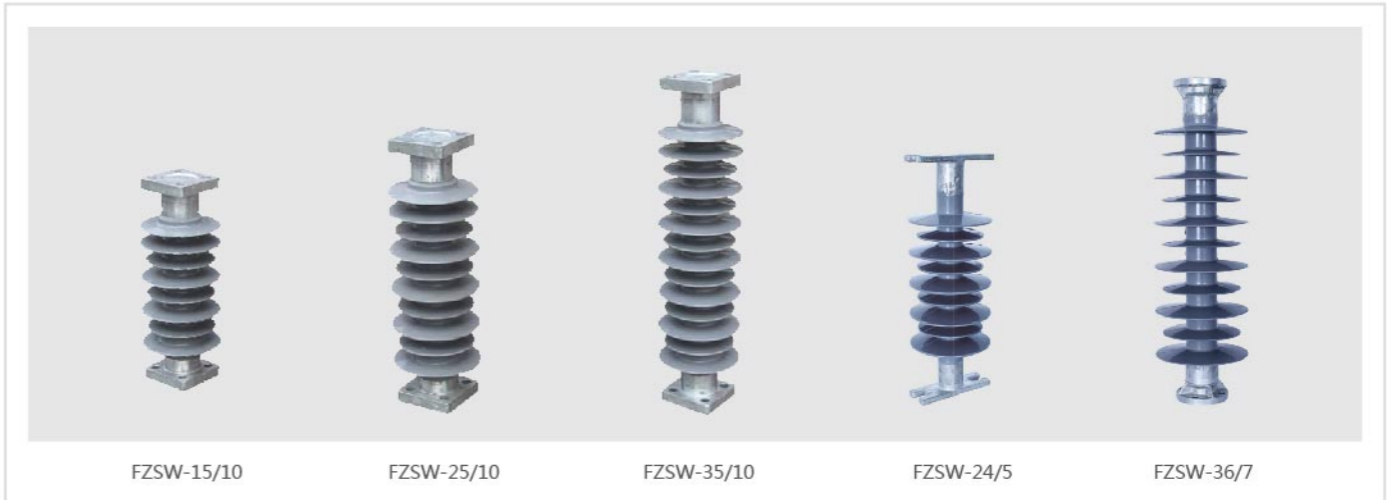

## ▶ LINE POST INSULATOR



## ▶ ISOLATOR SWITCH



## ▶ POLYETHYLENE PIN TYPE INSULATOR AND ACCESSORY

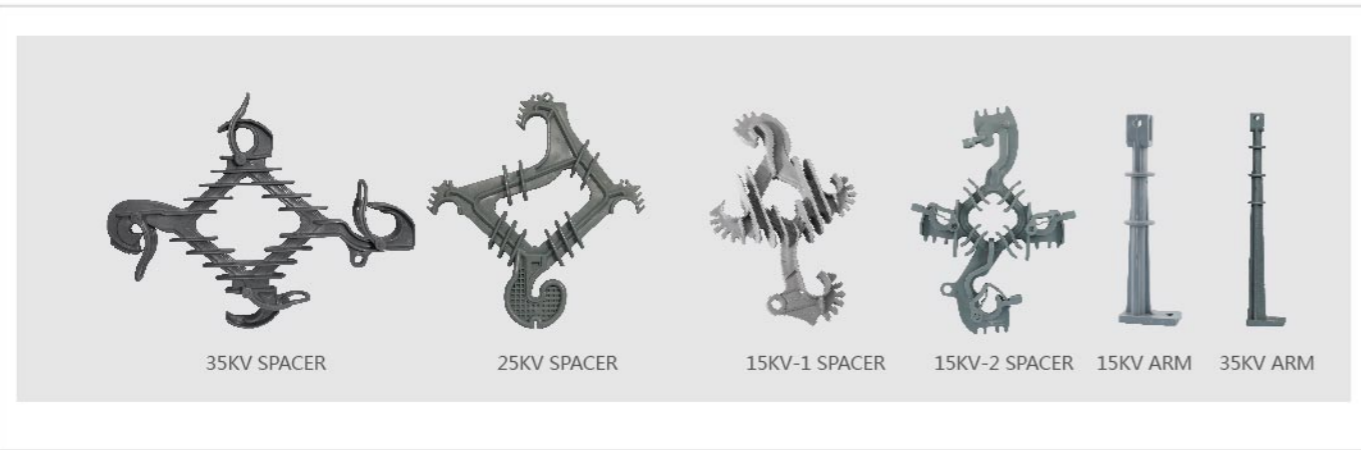
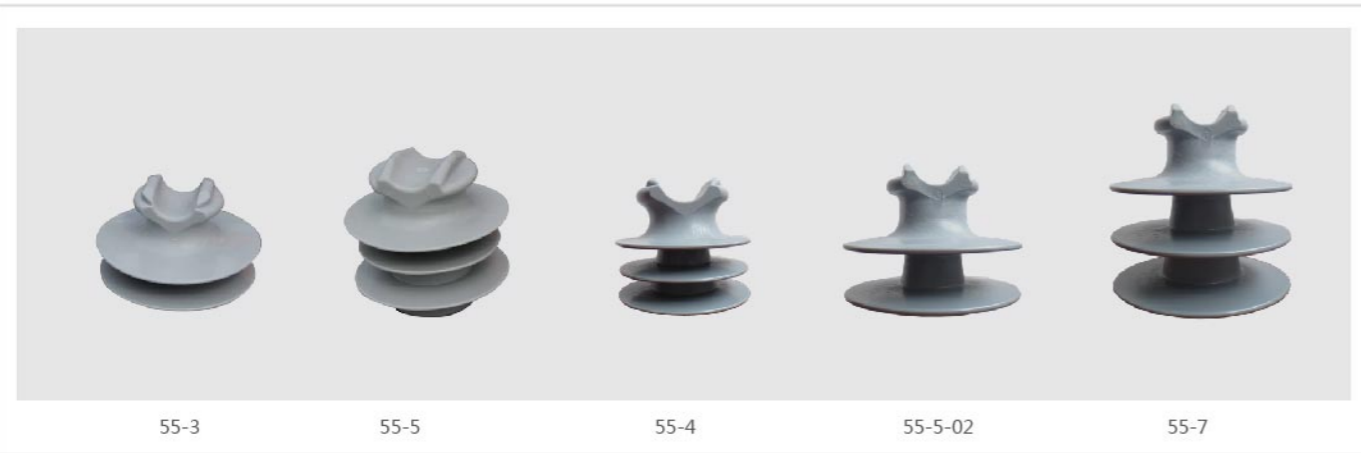

## ▶ FUSE CUT OUT SWITCH

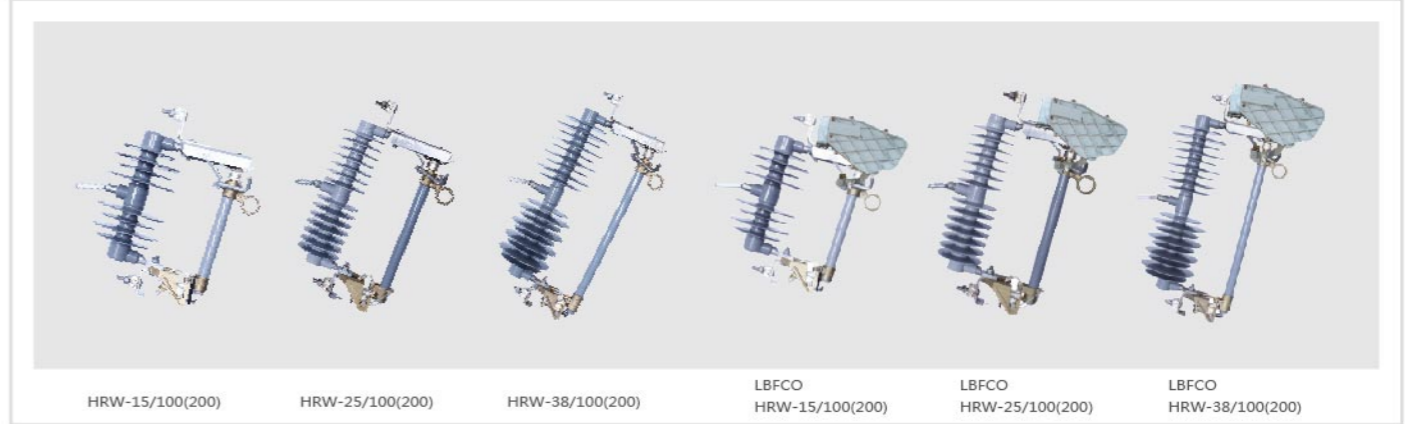

## ▶ SURGE ARRESTOR



▶ **FRP ELECTRICAL PRODUCTS SERIES**



▶ **CABLE COVER**

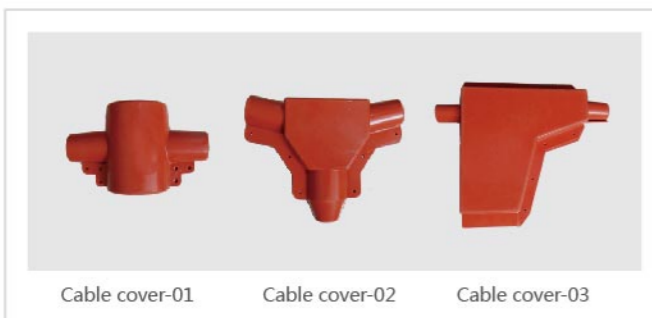

▶ **PIN POST HOUSING**



▶ **SILICONE COMPOUND**

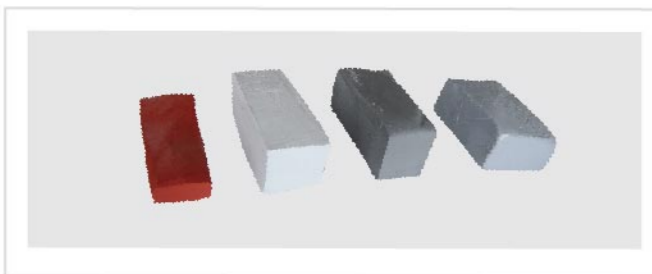

▶ **NEW DEVELOPING PRODUCTS**

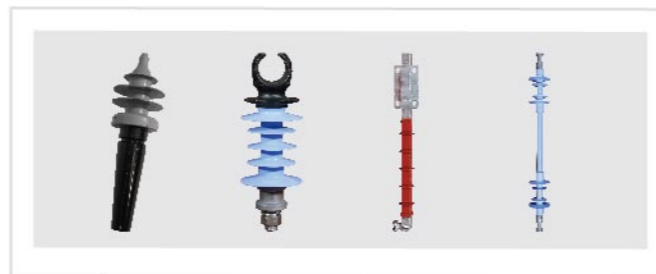

▶ **END FORGING FITTINGS FOR INSULATOR**





## ▶ END FORGING FITTINGS FOR INSULATOR



## ▶ PROCESS FOR FUSE CUT OUT SWITCH & ARRESTOR



## ▶ ADVANCED MANUFACTURING PROCESS FOR INSULATOR

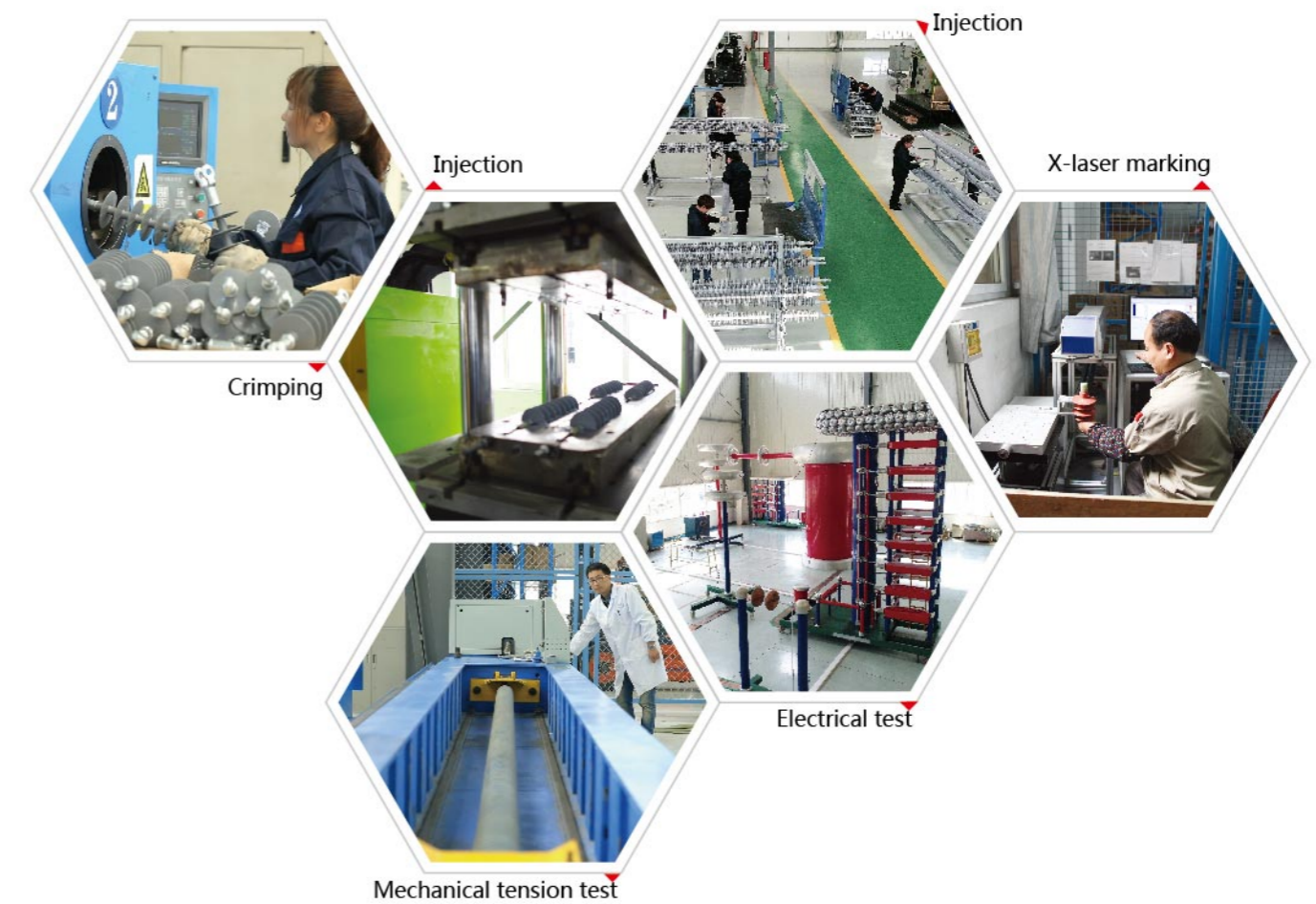

## ▶ QUALITY CONTROL & TEST PLAN



## ▶ QUALITY CONTROL CHART FOR INSULATOR

